

FICHE TECHNIQUE

Structure en bois bilaminé traité en autoclave.
 . Panneaux de recouvrement en polyéthylène
 L170 cm X H 155 cm.

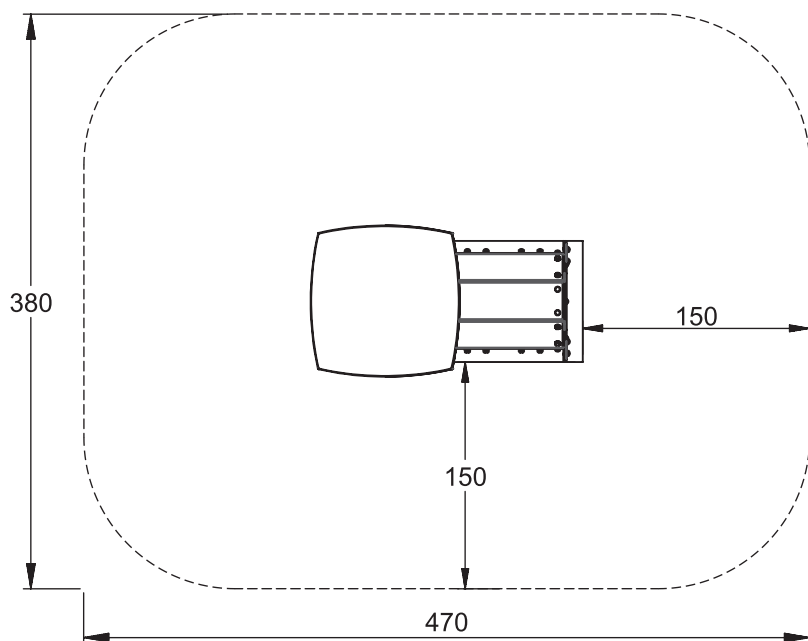
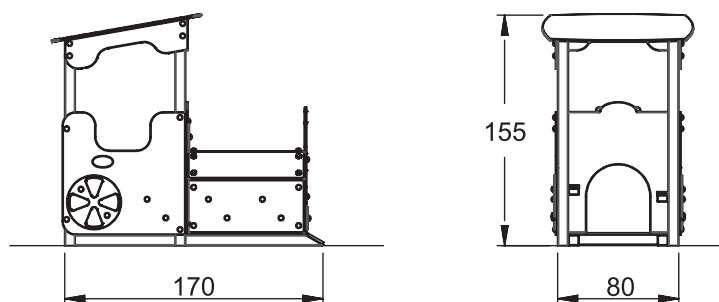

MATERIAUX:

- Bois de pin sylvestre traité en autoclave norme : EN-335. Garantie : 10 ans.
- Accessoires décoratifs en polyéthylène.
- Visserie et boulonnerie électro-galvanisées .

